

# Mounting Panel

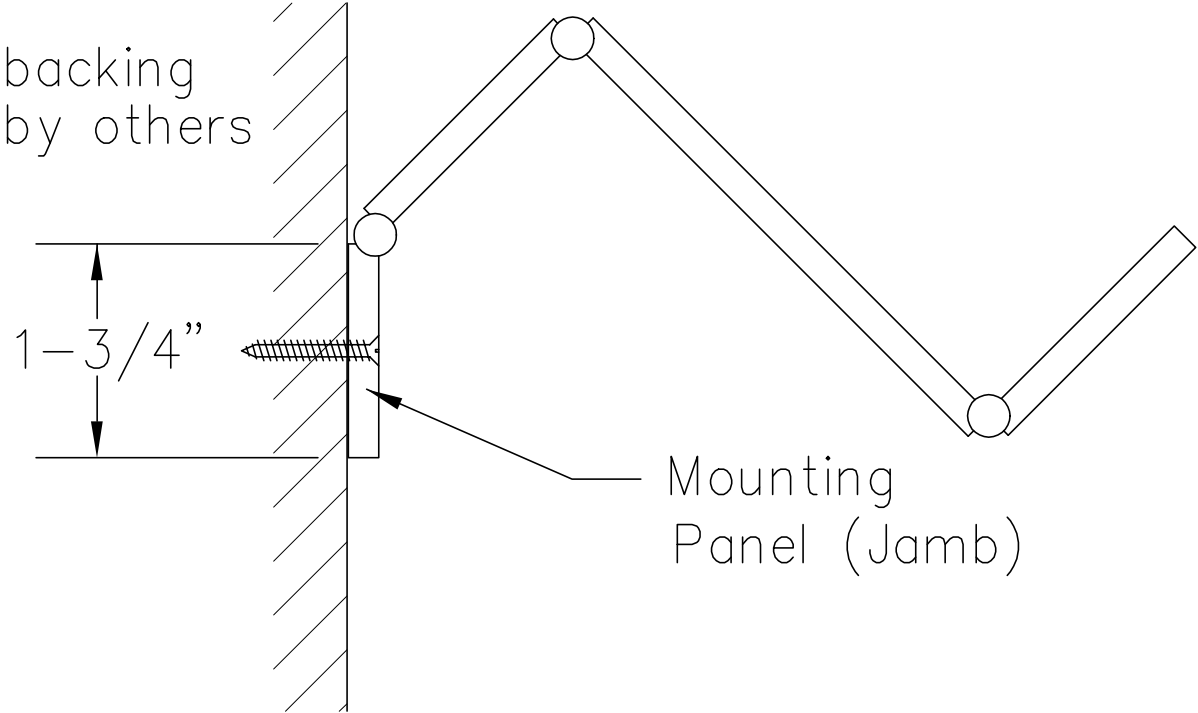

*Direction of mounting panel (jamb)  
varies based on door construction.  
Consult factory for specific information.*

CAD MPAN-240

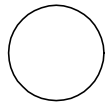

MOUNTING PANEL — MODEL 240